



European Technical Assessment

ETA- 15/0810 of 12/04/2019

English translation prepared by CSTB - Original version in French language

General Part

Nom commercial:

Trade name:

**Blue-Tip 2 Screw-Bolt, Blue-Tip 2 Screw-Bolt+
Hangermate, Hangermate+**

Famille de produit:

Product family:

**Vis à béton pour usage multiple et pour applications non
structurelles dans le béton**

***Concrete screw for multiple use and for non-structural
applications in concrete***

Titulaire:

Manufacturer:

DEWALT / Powers
Richard-Klinger-Str. 11
65510 Idstein
Germany

Usine de fabrication:

Manufacturing plant:

Usine 5, Usine 2
Plant 5, Plant 2

Cette evaluation contient:

This assessment contains:

12 pages incluant 10 pages d'annexes qui font partie intégrale
de cette évaluation

***12 pages including 10 pages of annexes which form an integral
part of this assessment***

Base de l'ETE:

Basis of ETA:

EAD 330747-00-0601, Version Mai 2018
EAD 330747-00-0601, Version May 2018

Cette evaluation remplace:

This Assessment replaces:

ETA-15/0810 du 13/02/2017
ETA-15/0810 of 13/02/2017

Specific Part

1 Technical description of the product

The Power Screwbolt is an anchor made of zinc plated steel or mechanically galvanized steel of size 6 mm. The anchor is screwed into a predrilled cylindrical drill hole drilled with a standard or hollow drill bit. The special thread of the anchor cuts an internal thread into the member while setting. The anchorage is characterised by mechanical interlock in the special thread. The illustration and the description of the product are given in Annexes A.

2 Specification of the intended use

The performances given in Section 3 are only valid if the anchor is used in compliance with the specifications and conditions given in Annexes B.

The provisions made in this European technical assessment are based on an assumed working life of the anchor of 50 years. The indications given on the working life cannot be interpreted as a guarantee given by the producer, but are to be regarded only as a means for choosing the right products in relation to the expected economically reasonable working life of the works.

3 Performance of the product

3.1 Mechanical resistance and stability (BWR 1)

The essential characteristics regarding mechanical resistance and stability are included under the Basic Works Requirement Safety in use.

3.2 Safety in case of fire (BWR 2)

Essential characteristic	Performance
Reaction to fire	Anchorage satisfy requirements for Class A1
Characterisitc resistance under fire exposure according to EN 1992-4	See Annex C 2

3.3 Hygiene, health and the environment (BWR 3)

Regarding dangerous substances contained in this European technical approval, there may be requirements applicable to the products falling within its scope (e.g. transposed European legislation and national laws, regulations and administrative provisions). In order to meet the provisions of the Construction Products Directive, these requirements need also to be complied with, when and where they apply.

3.4 Safety in use (BWR 4)

Essential characteristic	Performance
Characterisitc values for resistance for static and quasi static loads according to EN 1992-4	See Annex C 1

3.5 Protection against noise (BWR 5)

Not relevant.

3.6 Energy economy and heat retention (BWR 6)

Not relevant.

3.7 Sustainable use of natural resources ((BWR 7)

For the sustainable use of natural resources no performance was determined for this product.

3.8 General aspects relating to fitness for use

Durability and Serviceability are only ensured if the specifications of intended use according to Annex B 1 are kept.

4 Assessment and verification of constancy of performance (AVCP)

According to Decision of the Commission of 17 February 1997 (97/161/EC) (OJ L 062 of 04.03.97 p. 41-42), the system of assessment and verification of constancy of performance (see Annex V and Article 65 Paragraph 2 to Regulation (EU) No 305/2011) given in the following table applies.

Product	Intended use	Level or class	System
Metal anchors for use in concrete	For use in redundant systems for fixing and/or supporting to concrete elements such as lightweight suspended ceilings, as well as installations	—	2+

5 Technical details necessary for the implementation of the AVCP system

Technical details necessary for the implementation of the Assessment and verification of constancy of performance (AVCP) system are laid down in the control plan deposited at Centre Scientifique et Technique du Bâtiment.

The manufacturer shall, on the basis of a contract, involve a notified body approved in the field of anchors for issuing the certificate of conformity CE based on the control plan.

The original French version is signed by

Technical Director

Anchor:



Head Marking:

Marking D x L where

D = Nominal diameter of the bore hole [mm]

L = Length of anchor [mm]



Anchor in use:

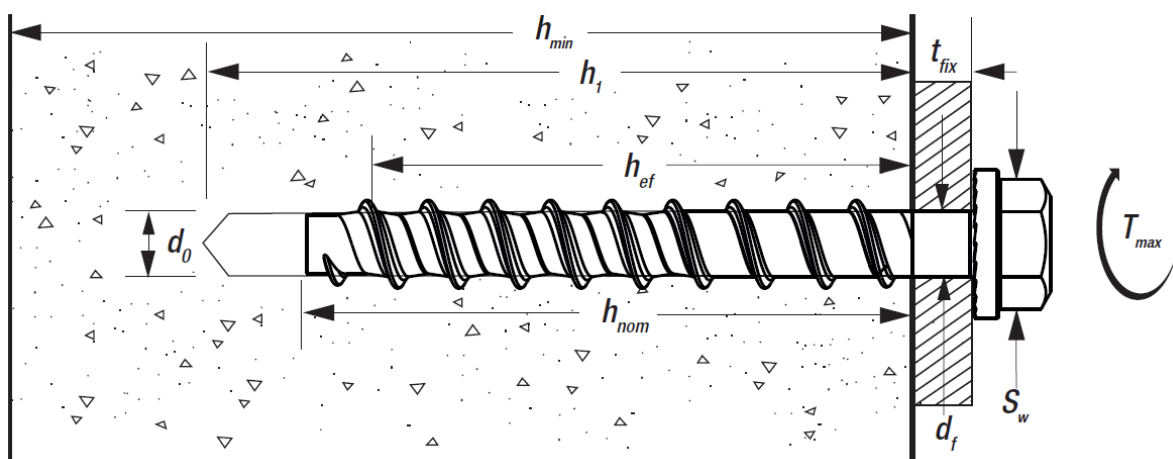

BT2 Screw-Bolt

Product description
Installed condition

Annex A1

Anchor in use in precast pre-stressed hollow core slabs:

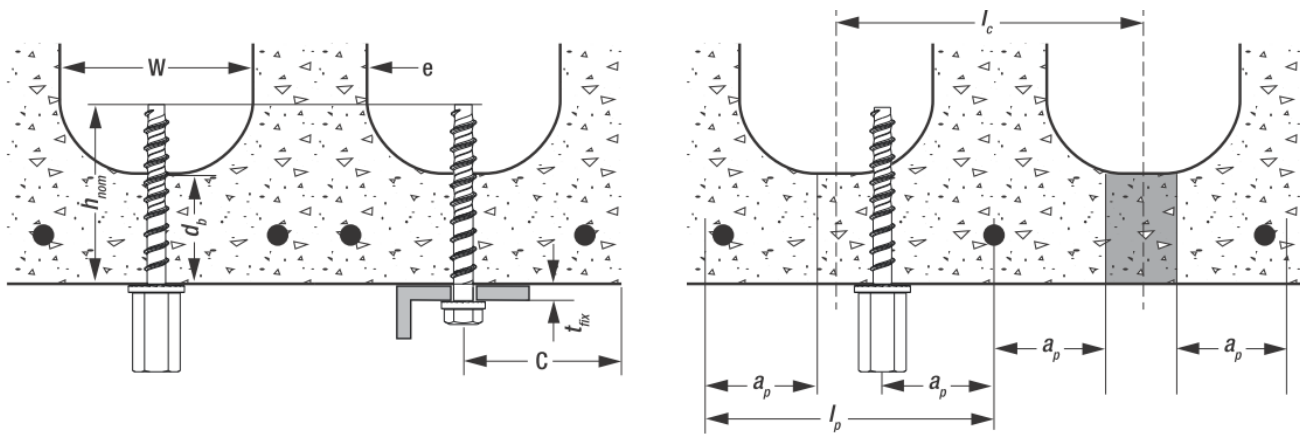

Core distance cavity

$$l_c \geq 100 \text{ mm}$$

Prestressing steel distance

$$l_p \geq 100 \text{ mm}$$

Distance between anchor position

$$a_p \geq 50 \text{ mm}$$

and prestressing steel

Bottom flange thickness

$$d_b$$

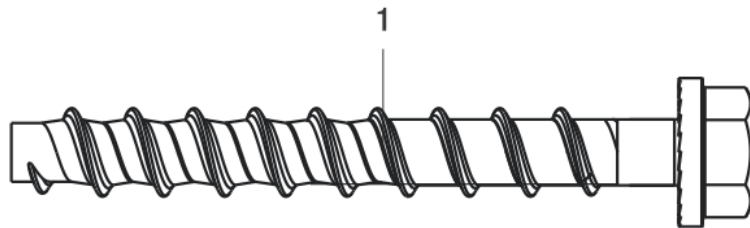

Table 1: Materials

Part	Version	Material	Protection
1	Blue-Tip 2 Screw-Bolt Hangermate Zinc Plated Version	C-Steel, special hardened	Zinc plated > 5 μm
1	Blue-Tip 2 Screw-Bolt Hangermate Mechanically Galv. Version	C-Steel, special hardened	Zinc plated > 50 μm

BT2 Screw-Bolt

Product description

Installed condition
 Materials

Annex A2

Table 2: Different head styles

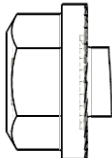
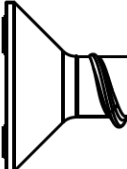
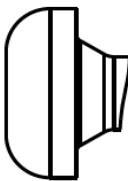
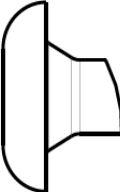
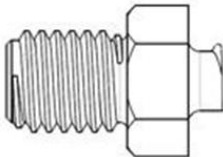
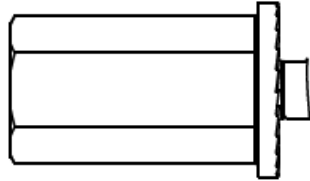
Drawing	Denomination	Abbreviation	Diameters
	Hex Head Version	BT2 HH	6
	Countersunk Version	BT2 CSK	6
	Pan Head Version	BT2 Pan	6
	Dome Head Version	BT2 Dome	6
	External Thread Version Single thread M6 Single thread M8 Single thread M10	BT2 EXT M6 BT2 EXT M8 BT2 EXT M10	6
	Internal Thread Version Single thread M6 Single thread M8 Single thread M10 Step thread M8/ M10	BT2 Hanger M6 BT2 Hanger M8 BT2 Hanger M10 BT2 Hanger M8/ M10	6

BT2 Screw-Bolt

Product description
 Material

Annex A3

Specifications of intended use

Anchorage subject to:

- Static, quasi-static loads and fire exposure

Base materials:

- Cracked concrete and non-cracked concrete.
- Reinforced or unreinforced normal weight concrete of strength classes C 20/25 at least to C50/60 at most according to EN 206-1: 2013.
- Precast, prestressed hollow concrete slabs with strength classes C30/37 to C50/60.

Use conditions (Environmental conditions):

- Structures subject to dry internal conditions.

Design:

- The anchorages are designed under the responsibility of an engineer experienced in anchorages and concrete work.
- The anchorages are designed under consideration of EN 1992-4.
- For application with resistance under fire exposure the anchorages are designed under consideration in accordance with method given in EN 1992-4.
- Verifiable calculation notes and drawings are prepared taking account of the loads to be anchored. The position of the anchor is indicated on the design drawings.
- The anchor may only be used if in the design and installation specifications for the fixture the excessive slip or failure of one anchor will not result in a significantly violation of the requirements on the fixture in the serviceability and ultimate state
- The anchor is to be used only for multiple use for non-structural applications, the definition of multiple use according to the Member States is given in the EAD 330747-00-0601.

Installation:

- Anchor installation carried out by appropriately qualified personnel and under the supervision of the person responsible for technical matters of the site.
- Use of the anchor only as supplied by the manufacturer without exchanging the components of an anchor.
- Anchor installation in accordance with the manufacturer's specifications and drawings and using the appropriate tools.
- Effective anchorage depth, edge distances and spacing not less than the specified values without minus tolerances.
- Hole drilling by hammer drill with standard or hollow drill bit.
- Cleaning of the hole of drilling dust. This step can be omitted if a hollow drill bit has been used.
- In case of aborted hole, drilling of new hole at a minimum distance of twice the depth of the aborted hole, or smaller distance provided the aborted drill hole is filled with high strength mortar and no shear or oblique tension loads in the direction of aborted hole.
- The anchor is suited for installation with a torque wrench by hand and for installation with a suitable impact wrench.

BT2 Screw-Bolt

Intended Use
Specifications

Annex B1

Table 3: Anchor dimensions

				BT2 - 6					
				HH	CSK	Pan	Dome	Hanger	EXT
Length of the anchor	Min.	L	[mm]	35	40	35	35	35	35
	Max.		[mm]	160	160	160	160	55	55
Fixture thickness	Max.	t _{fix}	[mm]	125	125	125	125	0	0
Diameter of the shaft		d _k	[mm]	5,9					
Outer diameter of the thread		d ₀	[mm]	7,9					
Width torque wrench		SW	[mm]	10	-	-	-	10	13
TORX			[-]	-	T40	T40	T30	-	

Table 4: Installation data

				BT2 - 6	
Drill hole diameter	d _{cut}	[mm]	≤ 6,45		
Drill hole depth	h ₁	[mm]	45		
Nominal embedment depth	h _{nom}	[mm]	35		
Effective embedment depth	h _{ef}	[mm]	27,4		
Diameter through hole fixture	d _f	[mm]	9		
Min. member thickness	h _{min}	[mm]	80		
Minimum edge distance	c _{min}	[mm]	35		
Minimum spacing	s _{min}	[mm]	35		
Maximum installation torque	T _{inst,max}	[Nm]	< 15		
Maximum impact wrench torque	T _{imp,max}	[Nm]	205		
Examples setting tool		[-]	Impact Screw driver e.g. Dewalt DCF880 or DCF887		

BT2 Screw-Bolt

Intended Use

Installation parameters

Annex B2

Installation: Blue-Tip 2 Screw-Bolt and Hangermate

Hex Head Version / Countersunk Version / Pan Head Version / Dome Head Version

Standard Drill Bit

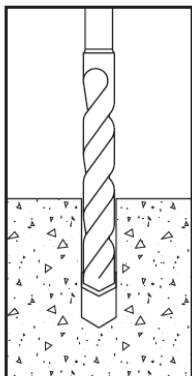

1.) Using the proper drill bit size, drill a hole into the base material to the required depth.

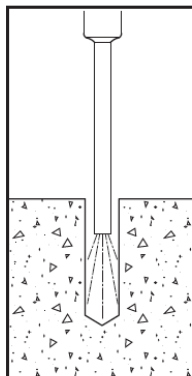

2.) Remove dust and debris from the hole using a hand pump or compressed air.

Hollow Drill Bit

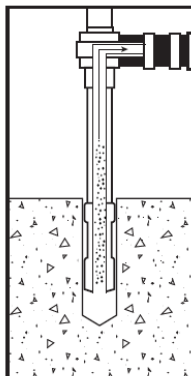

1. & 2.) Connect the hollow drill bit of proper size to a vacuum, and drill a hole into the base material to the required depth while the vac is running. The dust is removed during the drilling process.

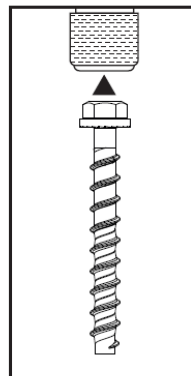

3.) Select impact wrench and mount the screw anchor head into the hex socket.

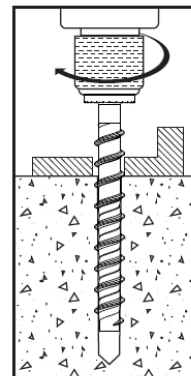

4.) Drive the anchor through the fixture into the hole at least to the minimum required embedment depth and until the head of the anchor comes into contact with the fixture.

External Thread Version / Hanger Version

Standard Drill Bit

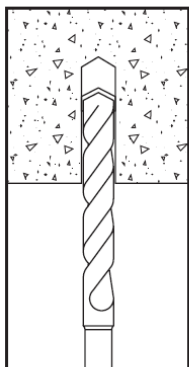

1.) Using the proper drill bit size, drill a hole into the base material to the required depth.

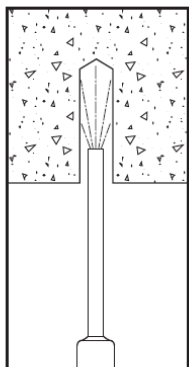

2.) Remove dust and debris from the hole using a hand pump or compressed air.

Hollow Drill Bit

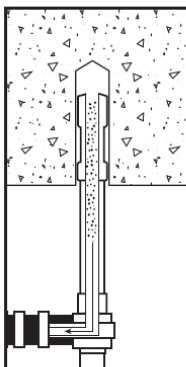

1. & 2.) Connect the hollow drill bit of proper size to a vacuum, and drill a hole into the base material to the required depth while the vac is running. The dust is removed during the drilling process.

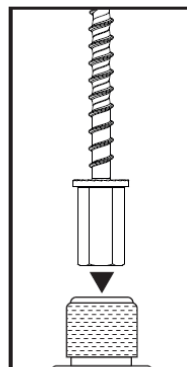

3.) Select impact wrench and mount the screw anchor head into the hex socket.

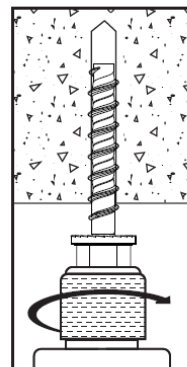

4.) Drive the anchor into the hole at least to the minimum required embedment depth and until the head of the anchor comes into contact with the base material.

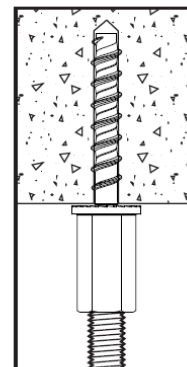

5.) Screw the threaded rod into the anchor head.

BT2 Screw-Bolt

Intended Use
 Installation instructions

Annex B3

Installation in precast pre-stressed hollow core slabs

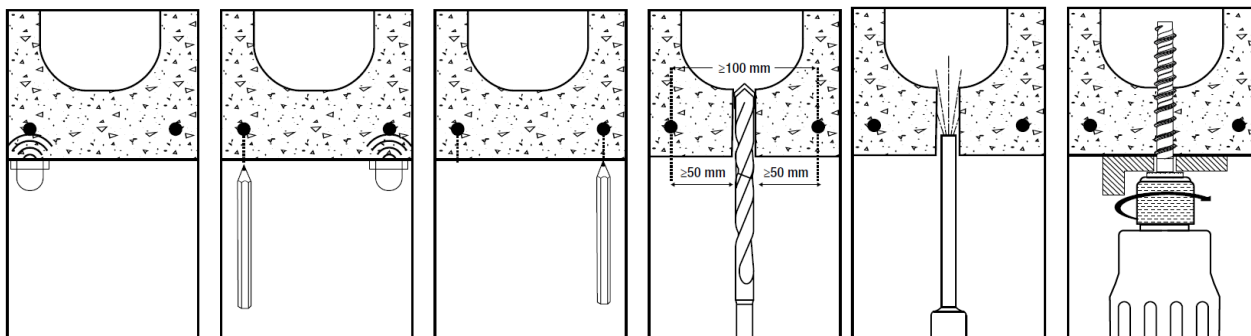

Note: Verify that internal spalling due to drilling has not reduced the available embedment below the value assumed for the design

Minimum spacing and edge distance of anchors and distance between anchor groups in precast pre-stressed hollow core slabs

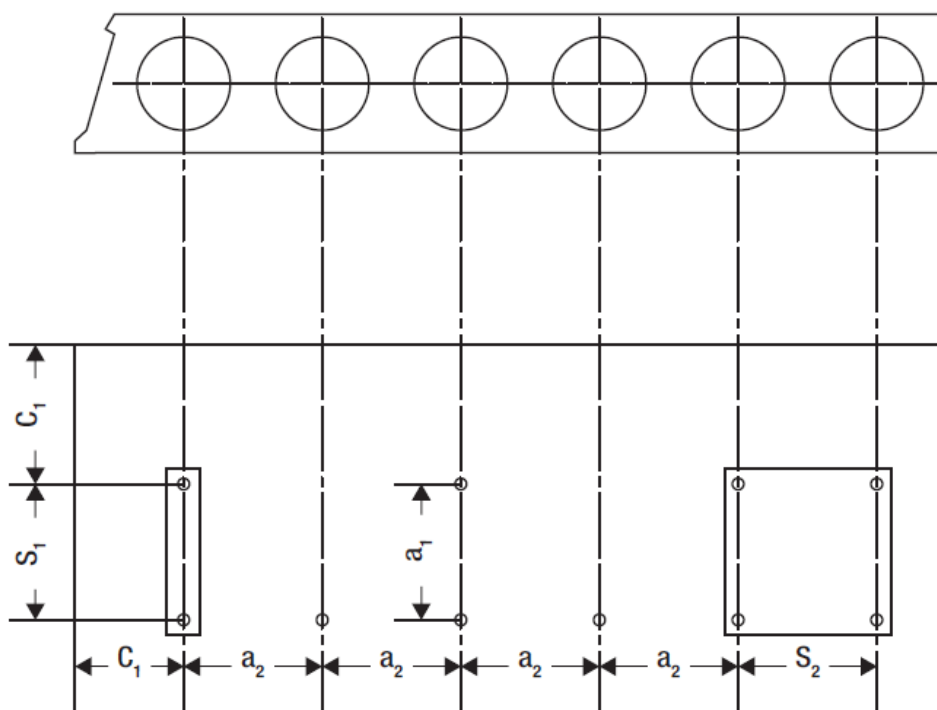

Minimum edge distance $c_{min} \geq 100\text{mm}$
 Minimum anchor spacing $s_{min} \geq 100\text{mm}$
 Minimum distance
 between anchor groups $a_{min} \geq 100\text{mm}$

c_1, c_2 edge distance
 s_1, s_2 anchor spacing
 a_1, a_2 distance between anchor groups

BT2 Screw-Bolt

Intended Use

Installation instructions

Annex B4

Table 5: Characteristic resistance for static and quasi static loads in C20/25 to C50/60 concrete

			BT2 - 6	
Head style			HH, CSK, Pan, Dome, Hanger, EXT	
Nominal embedment depth	$h_{nom} \geq$	[mm]	35	
Effective embedment depth	h_{ef}	[mm]	27,4	
All load directions				
Characteristic resistance	F_{Rk}	[kN]	3,5	
Installation safety factor	γ_{inst}	[-]	1,4	
Characteristic edge distance	c_{cr}	[mm]	100	
Characteristic spacing	s_{cr}	[mm]	200	
Increasing factor concrete strength	C30/37	[-]	1,10	
	C40/50	[-]	1,18	
	C50/60	[-]	1,25	
Shear load with lever arm				
Characteristic bending resistance	$M_{Rk,s}^0$	[N.m]	13,3	
Partial safety factor	γ_{Ms}		1,5	

Table 6: Characteristic values for static and quasi-static loads in precast pre-stressed hollow core slabs C30/37 to C50/60

			BT2 - 6	
Head style			HH, CSK, Pan, Dome, Hanger, EXT	
All load directions				
Bottom flange thickness	d_b	[mm]	≥ 35	≥ 25
Characteristic resistance	F_{Rk}	[kN]	2,5	0,5
Installation safety factor	γ_{inst}	[-]	1,4	1,4

BT2 Screw-Bolt

Characteristic resistance for static and quasi static loads according to EN 1992-4

Annex C1

Table 7: Characteristic resistance under fire exposure for design according to EN 1992-4

				BT2 - 6
Head style				HH, CSK, Pan, Dome, Hanger, EXT
Nominal anchorage depth	[mm]	$h_{nom} \geq$		35
All load directions				
Characteristic resistance	$F_{Rk,fi}$	[kN]	R30	0,24
			R60	0,21
			R90	0,17
			R120	0,12
Characteristic bending resistance	$M_{Rk,fi}$	[Nm]	R30	0,19
			R60	0,17
			R90	0,14
			R120	0,10
Edge distance	$c_{cr,fi}$	[mm]	R30...R120	100
Fastener spacing	$s_{cr,fi}$	[mm]	R30...R120	200

Design under fire exposure is performed according to the design method given in EN 1992-4. Under fire exposure usually cracked concrete is assumed.

EN 1992-4 covers design for fire exposure from one side. For fire attack from more than one side the edge distance must be increased to $c_{min} \geq 300$ mm and $\geq 2 \cdot h_{ef}$.

The anchorage depth has to be increased for wet concrete by at least 30 mm compared to the given value.

BT2 Screw-Bolt

Annex C2

Characteristic resistance under fire exposure according to EN 1992-4